

# ZAZA2 PBJ

Brevet déposé / Patent deposit

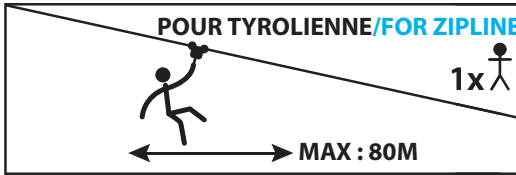
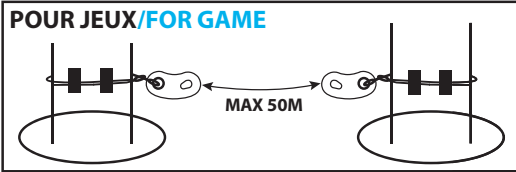

## AVANTAGES / ADVANTAGES

- Facile et simple à installer  
Easy to install
- 1 Sans SERRE-CÂBLE!  
No CLAMP
- 1 Sans maintenance  
No maintenance



**Safety Line / Ligne de vie :**  
ø 12 mm or 1/2"  
Galvanized steel wire rope with metal core /  
Câble acier galvanisé avec âme métallique  
7x19 / 1x19  
-Non rotating wire rope / Anti-giratoire  
-6x26 Swaged / Compacté  
**For any other type: do tests**  
**Pour tout autre type : faire des tests**

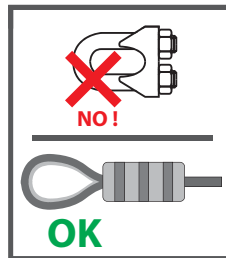

**EN 15567-1**  
**EN13411-3**  
**STANDARDS**  
**ACCT**

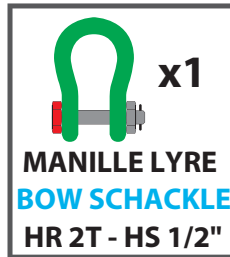
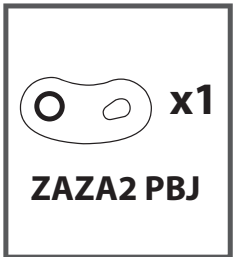

**JEU / FOR GAME**  
= 1 x GO 12 - LO 1/2"  
1250 Kg  
+ 1 x GO 10 - LO 7/16"  
CT/WLL: 1000 Kg

OU

**TYROLIENNE / ZIPLINE**  
= 1 x GO 14 - LO 9/16"  
2000 Kg  
+ 1 x GO 10 - LO 7/16"  
CT/WLL: 1000 Kg

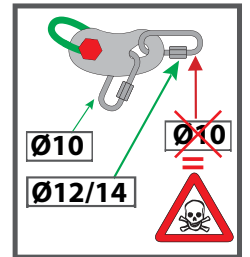

## EXEMPLES DE FIXATIONS (liste non-exhaustive) / FIXATION EXAMPLE (non-exhaustive list)

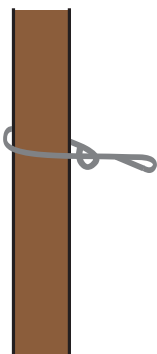

ELINGUE DE LEVAGE RONDE TEXTILE TYPE "E" CMU mini 2 tonnes  
ROUND TEXTILE SLING FOR LIFTING TYPE "E" WLL mini 2 tons

**NORMES :** EN 13411-1/7  
**STANDARDS:**

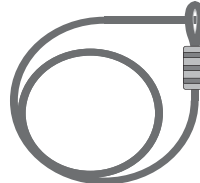
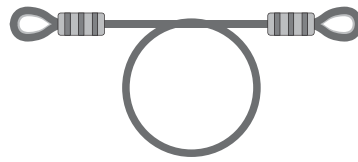

**CÂBLES ø12 or 1/2"**  
**ÂME MÉTALLIQUE**  
**METALLIC CORE**

**COSSE-COEUR / THIMBLE**



**Chain HR/HS ø 8/10 Grade 80 mini**



**La CMU des fixations doit être correctement dimensionnée / WLL of the fixing element must be correctly sized**

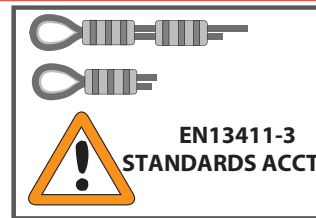

**Operation 1**

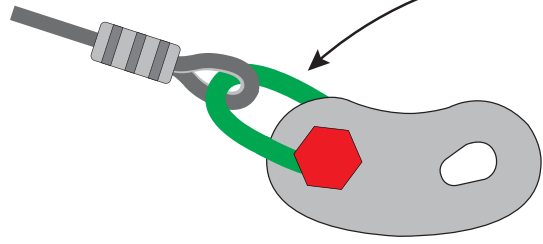

**x1**  **MANILLE LYRE/BOW SHACKLE**  
**= HR 2T - HS 1/2"**

**NORMES DE MONTAGE**  
**STANDARDS OF ASSEMBLY**



**EN 15567-1**  
**EN 13411-3**  
**STANDARDS - ACCT**

**Operation 2**

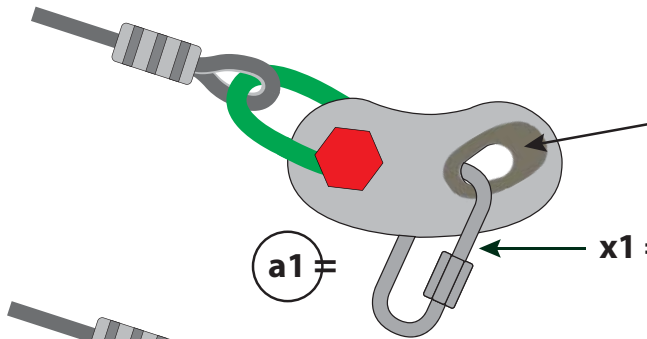

**x1**  **PLAQUE DE GUIDAGE**  
**GUIDING PLATE**

**a1**  $\neq$  **x1 = GO 10 - LO 7/16"**

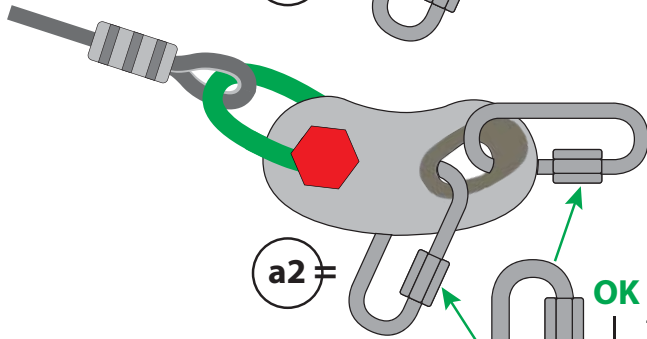

**POUR JEUX/FOR GAMES**  
**x1 = GO 12 - LO 1/2"**

**POUR TYROLIENNE/FOR ZIPLINE**  
**x1 = GO 14 - LO 9/16"**

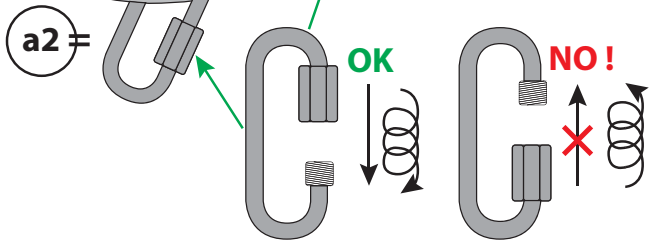

**Operation 3**

**● INSTALLATION DE LA PLATINE DE DEPART**  
**INSTALLATION of STARTING PLATE**

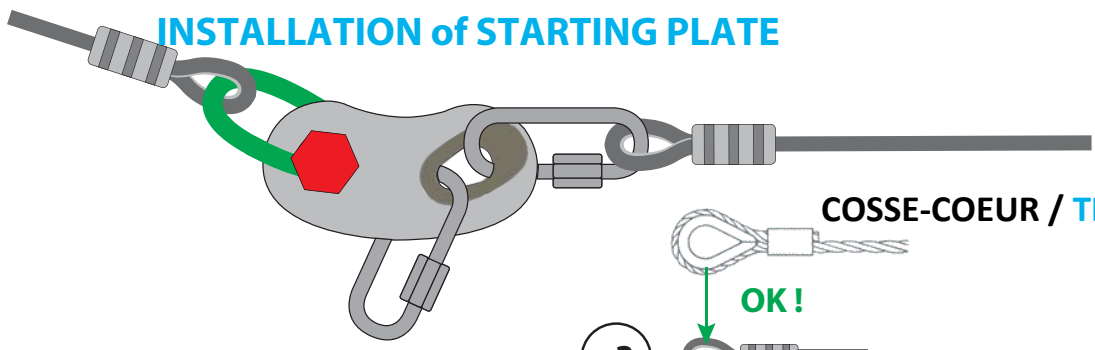

**COSSE-COEUR / THIMBLE**

**a3**  $\neq$  **OK!**  
**4 x 130KN**



## Operation 4

- INSTALLATION DE LA PLATINE D'ARRIVEE  
INSTALLATION of ARRIVALL PLATE

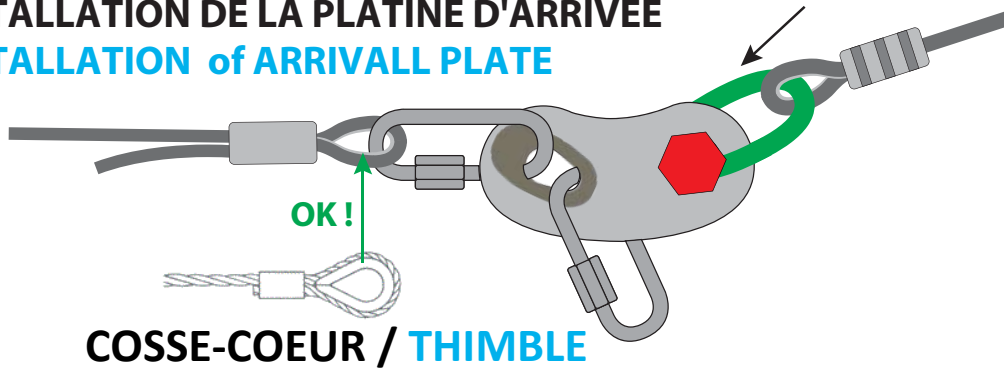

VOIR OPTION  
SEE OPTION  
Operation 7

## Operation 5

- TENSION DU CÂBLE  
CABLE TENSION

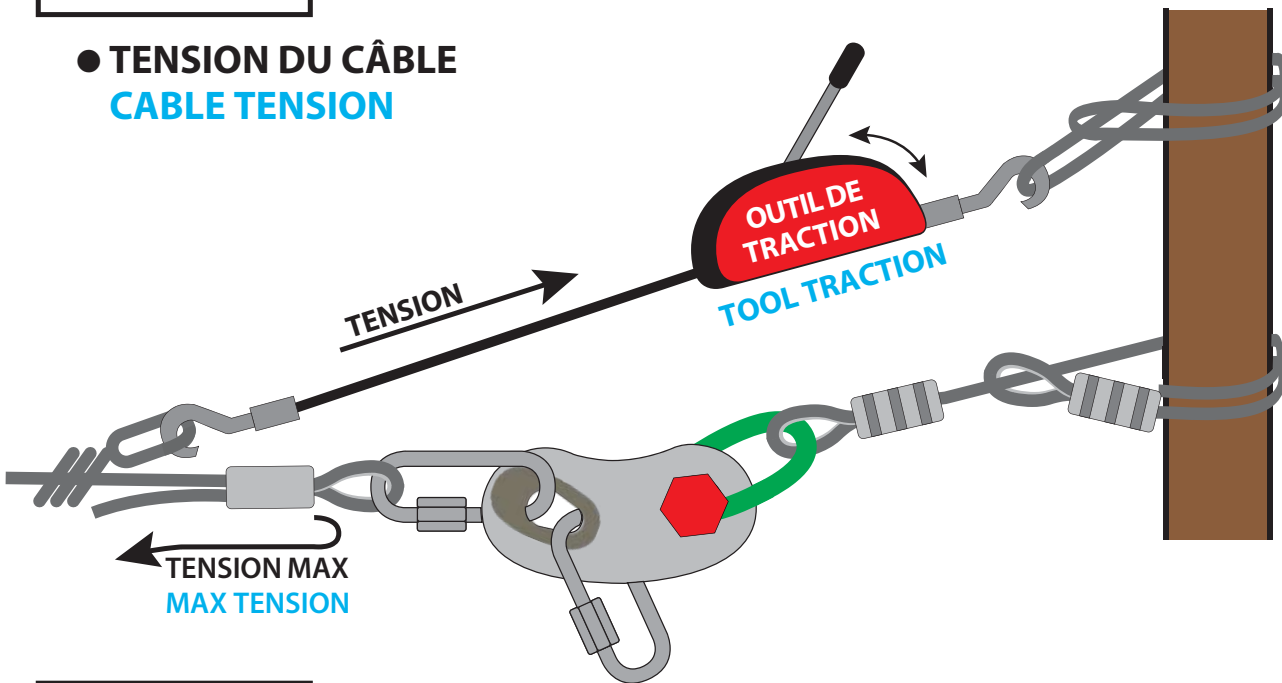

## Operation 6

- POUR SERTIR  
TO CRIMP

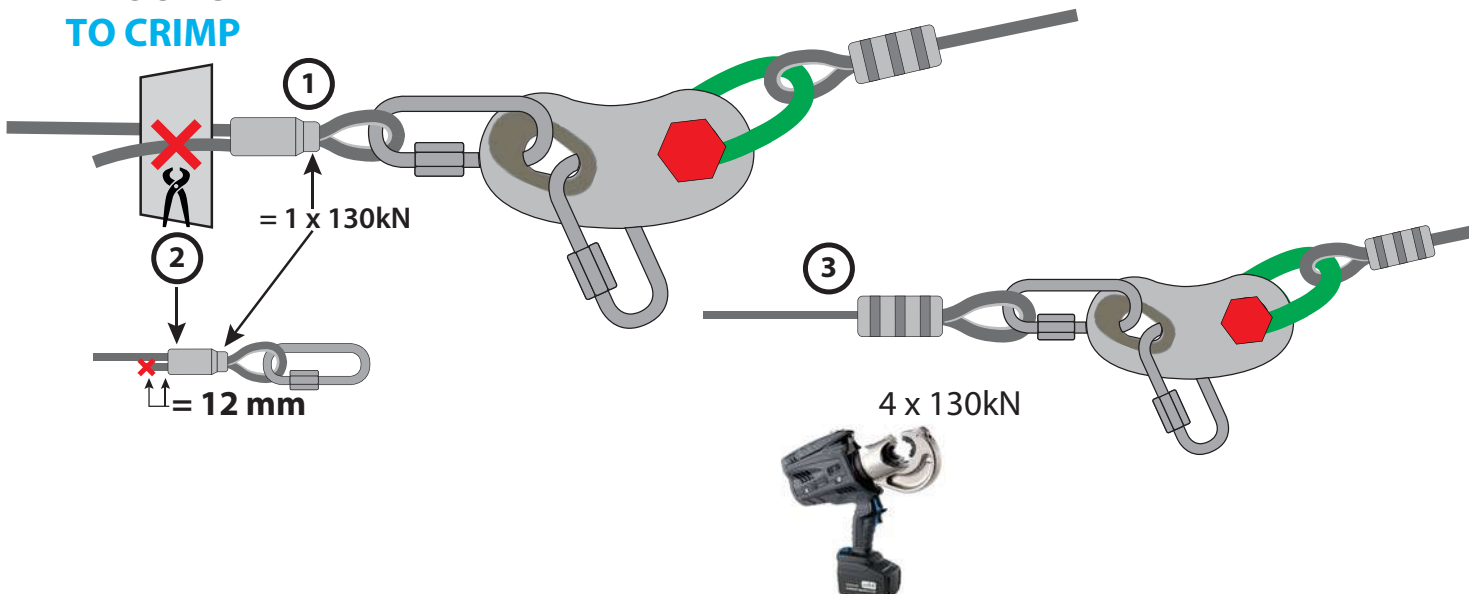

## Operation 7

- **OPTION:**  
SYSTEME DE TENSION = POUR TYROLIENNE  
TENSION SYSTEM = FOR ZIPLINE

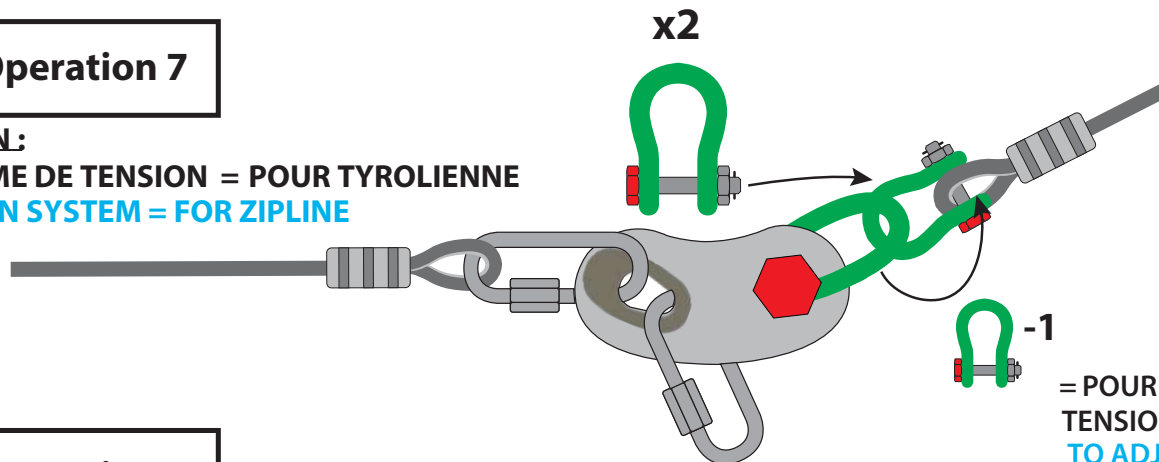

## Operation 8

- **RECOMMANDATION DE MONTAGE**  
RECOMMANDATION ASSEMBLY

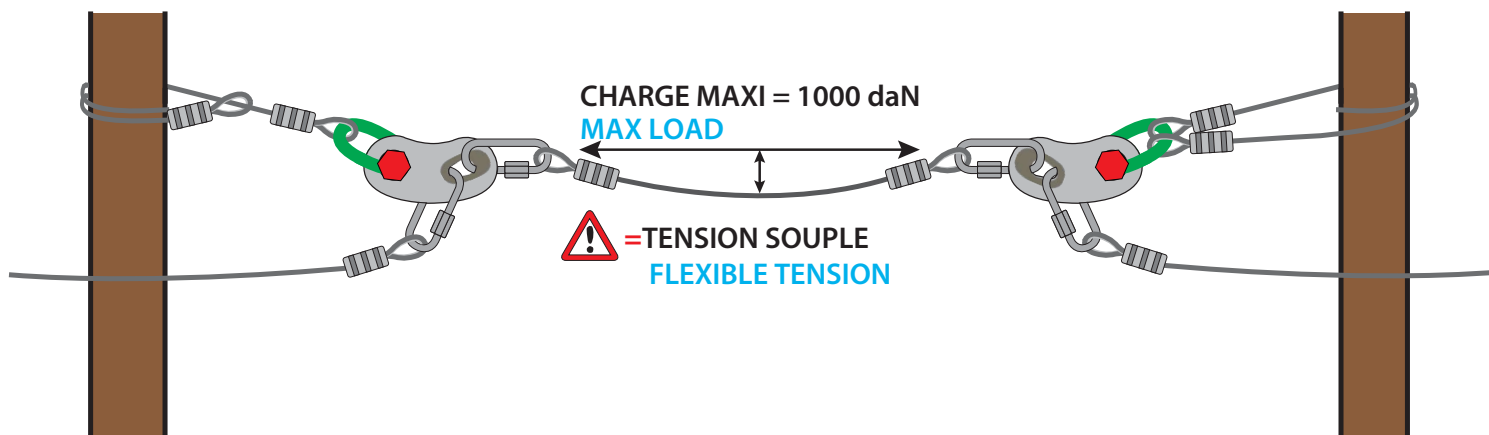

## Operation 9

- **JONCTION**  
JUNCTION

Exemples (non contractuel)  
de systèmes de fixations  
NOT contractual Examples  
system for fixation

