

ZAZA2 SWIVEL

4 WAYS ROTATING SWITCHING PLATE
AIGUILLAGE ROTATIF 4 VOIES

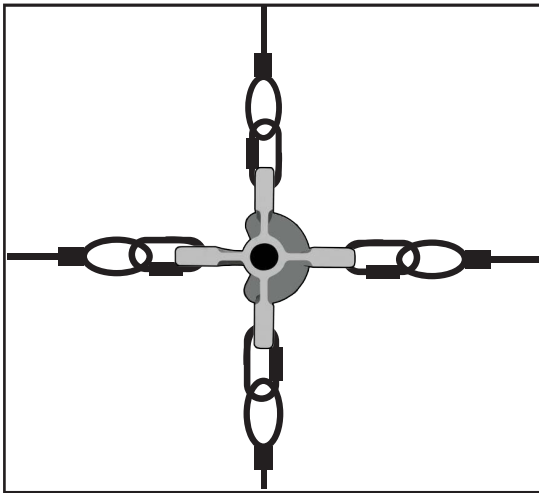

ADVANTAGES / AVANTAGES

- Échappatoire / Escape
- Bifurcation / Diversion
- Dépassement / Overtaking

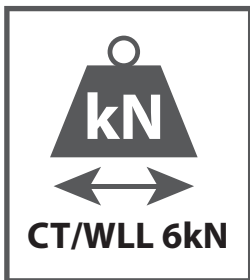

Safety Line / Ligne de vie :
ø 12 mm or 1/2 "

Galvanized steel wire rope with metal core /
Câble acier galvanisé avec âme métallique :-
-7x19
-Non rotating wire rope / Anti-giratoire
-6x26 Swaged/ Compacté

For any other type: do tests
Pour tout autre type : faire des tests

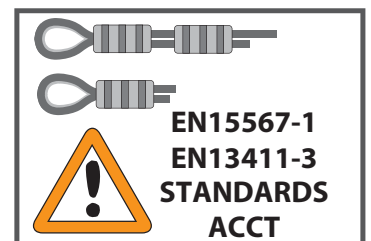
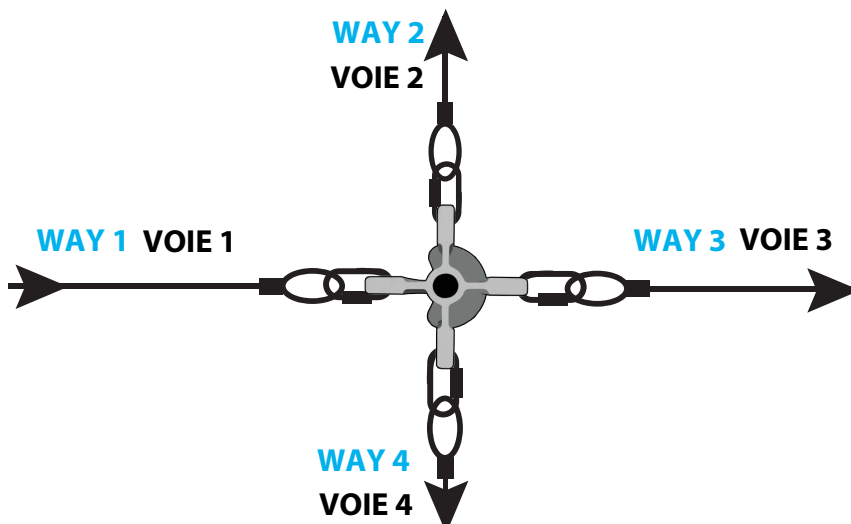
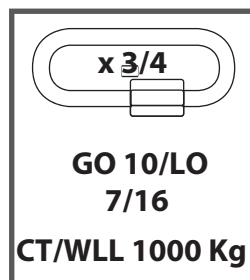
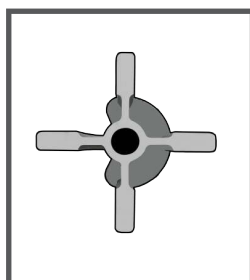
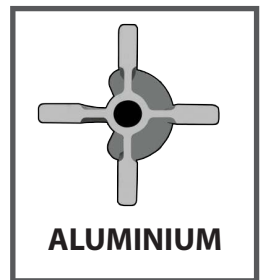
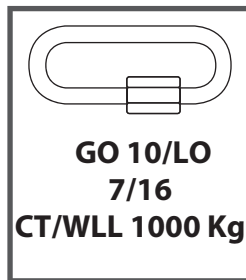

Opération 1

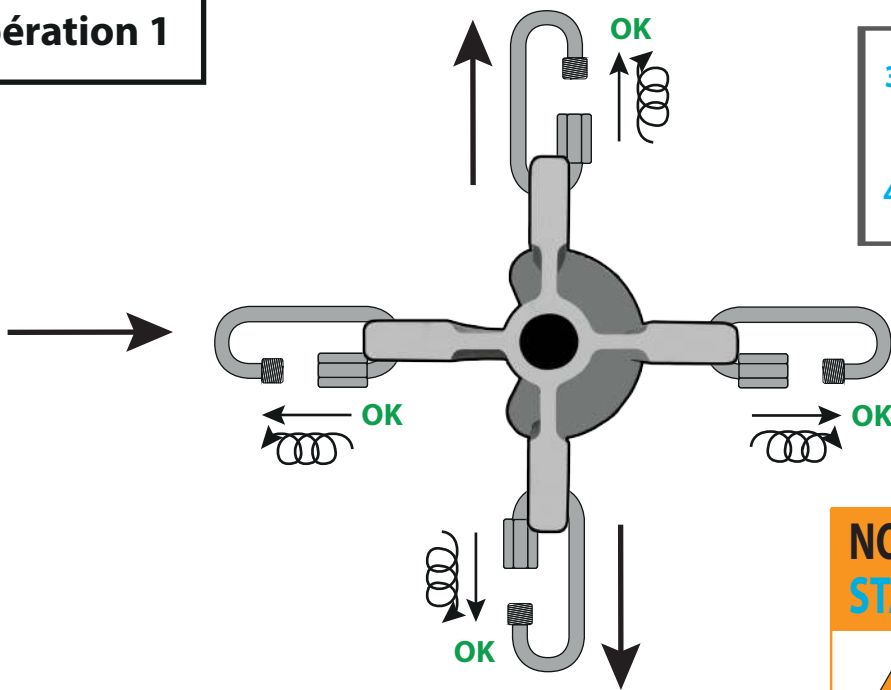

3WAYS / 3 VOIES = 3 X  + !

4WAYS / 4 VOIES = 4 X 

NORMES DE MONTAGE STANDARDS OF ASSEMBLY



EN 15567-1

EN13411-1/7

STANDARDS -ACCT

Opération 2

ASSEMBLY COMBINATION / COMBINAISON DE MONTAGE NON CONTRACTUAL EXAMPLE

● EXAMPLE 1 : 4 WAYS

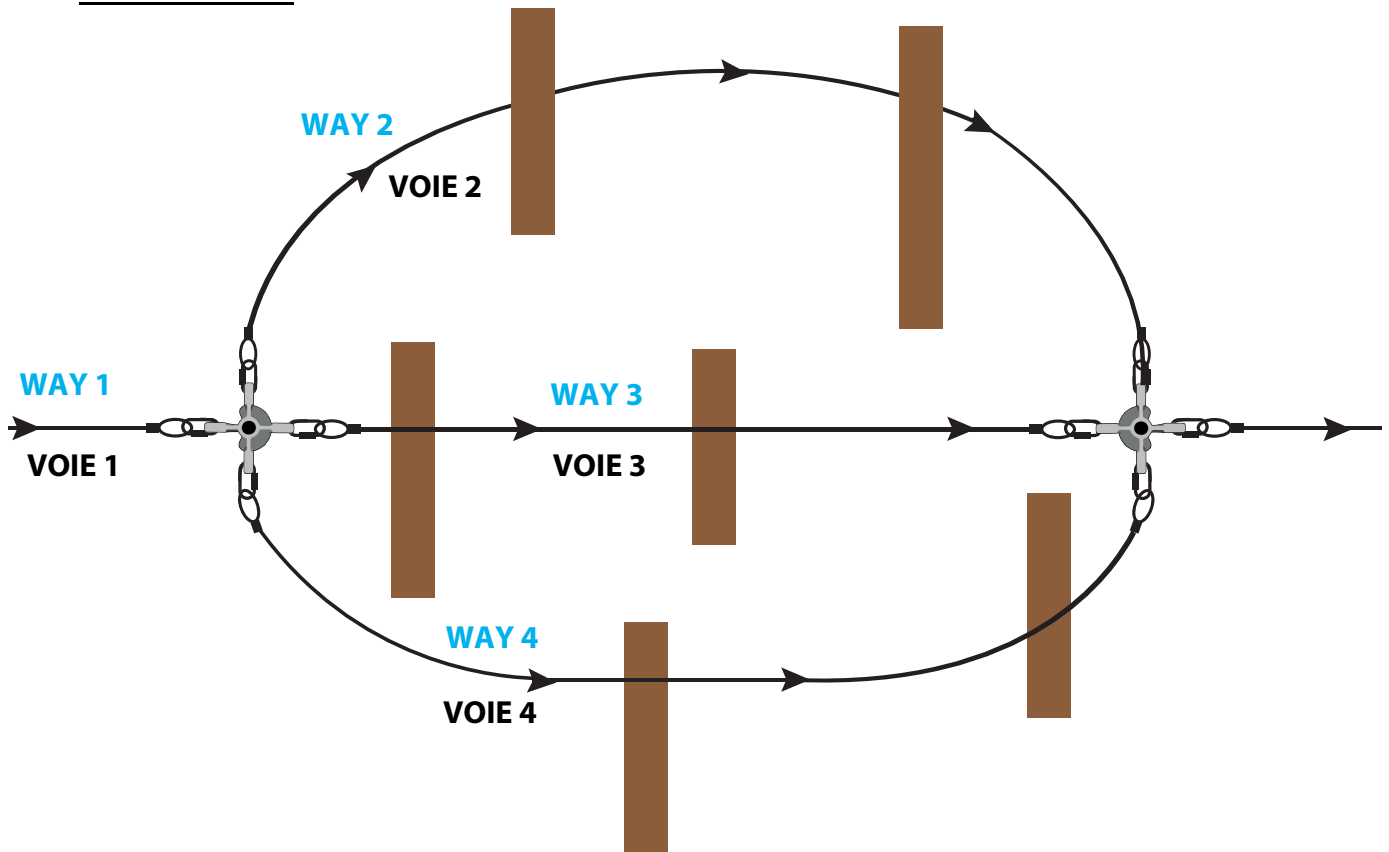

● **EXAMPLE 2 : 4 WAYS / 4 VOIES**

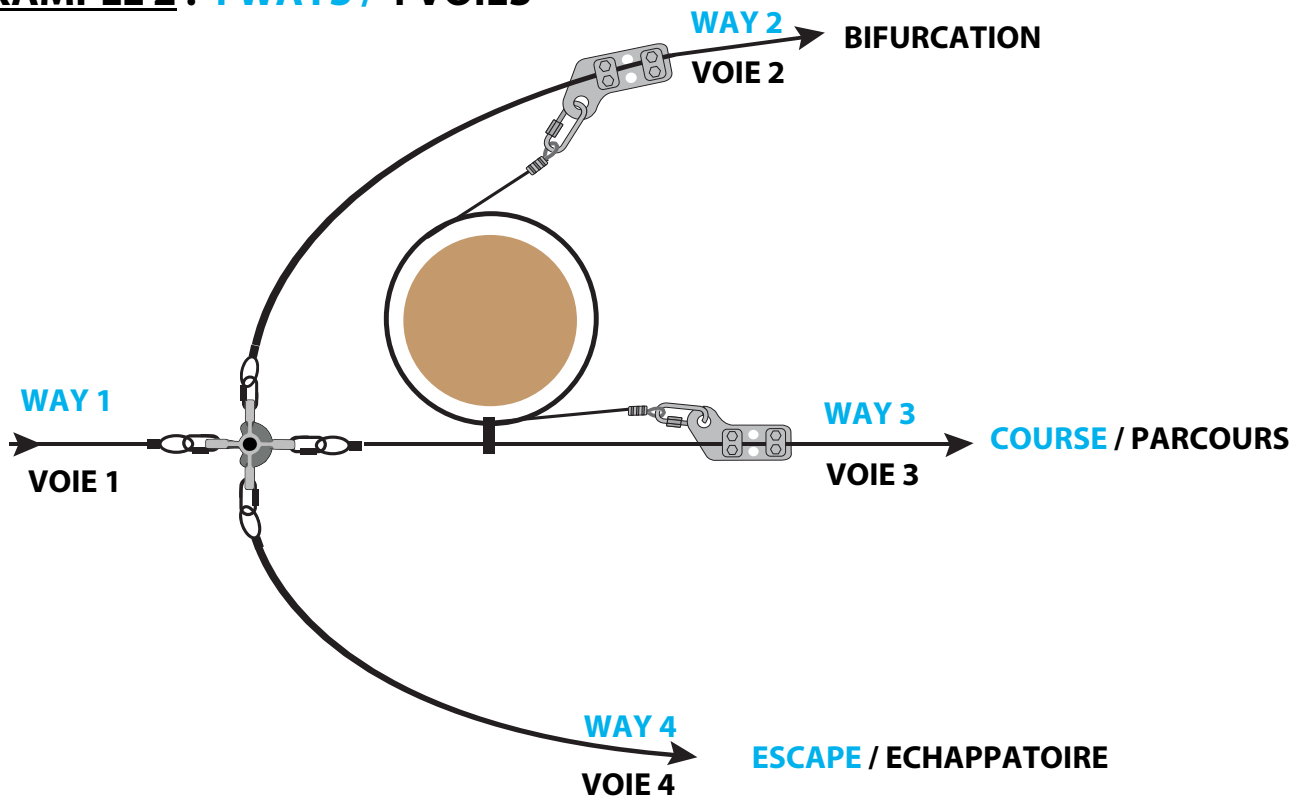

● **EXAMPLE 3 : 3 WAYS / 3 VOIES**



CONDEMN THE FOURTH WAY
CONDAMNER LA QUATRIEME VOIE

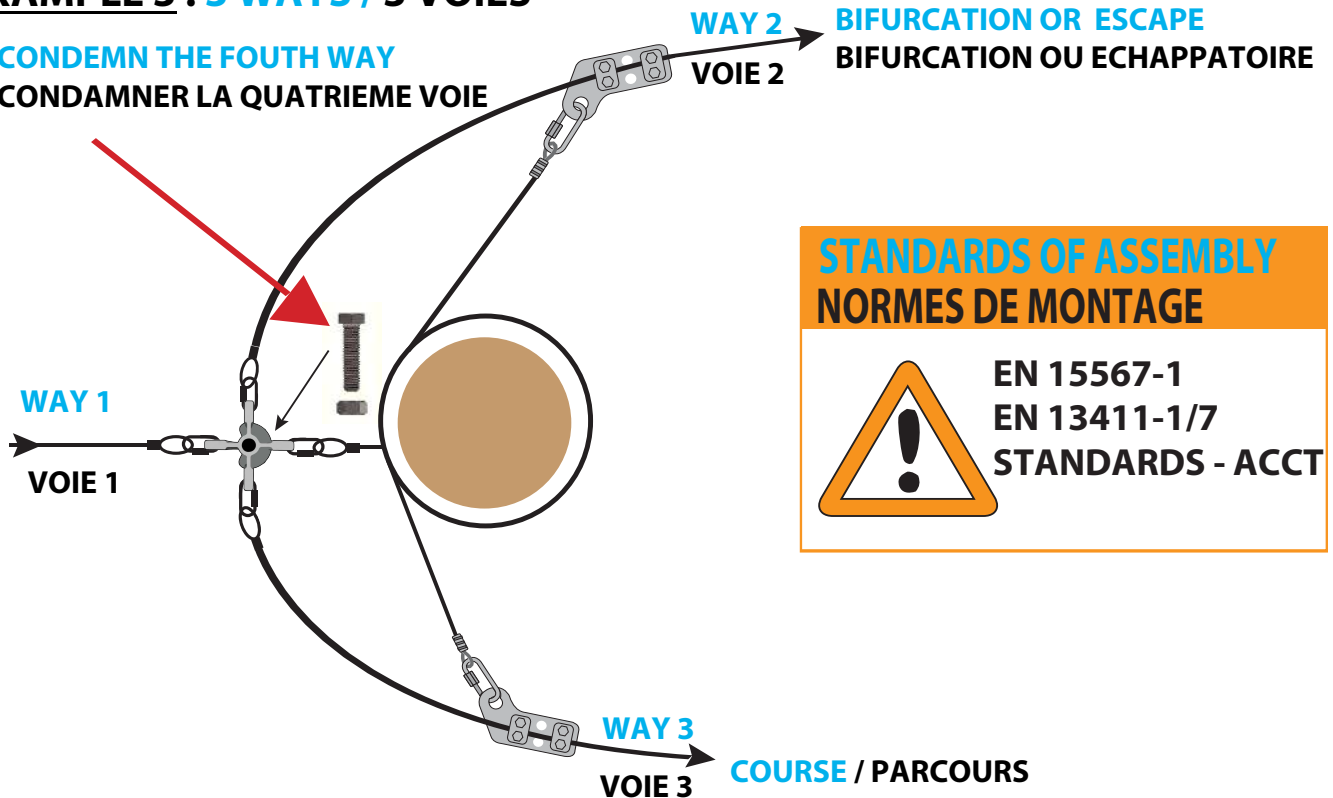

STANDARDS OF ASSEMBLY
NORMES DE MONTAGE



EN 15567-1
EN 13411-1/7
STANDARDS - ACCT

● **EXAMPLE 4 : 3 WAYS OVERTAKING/ 3 VOIES DEPASSEMENT**

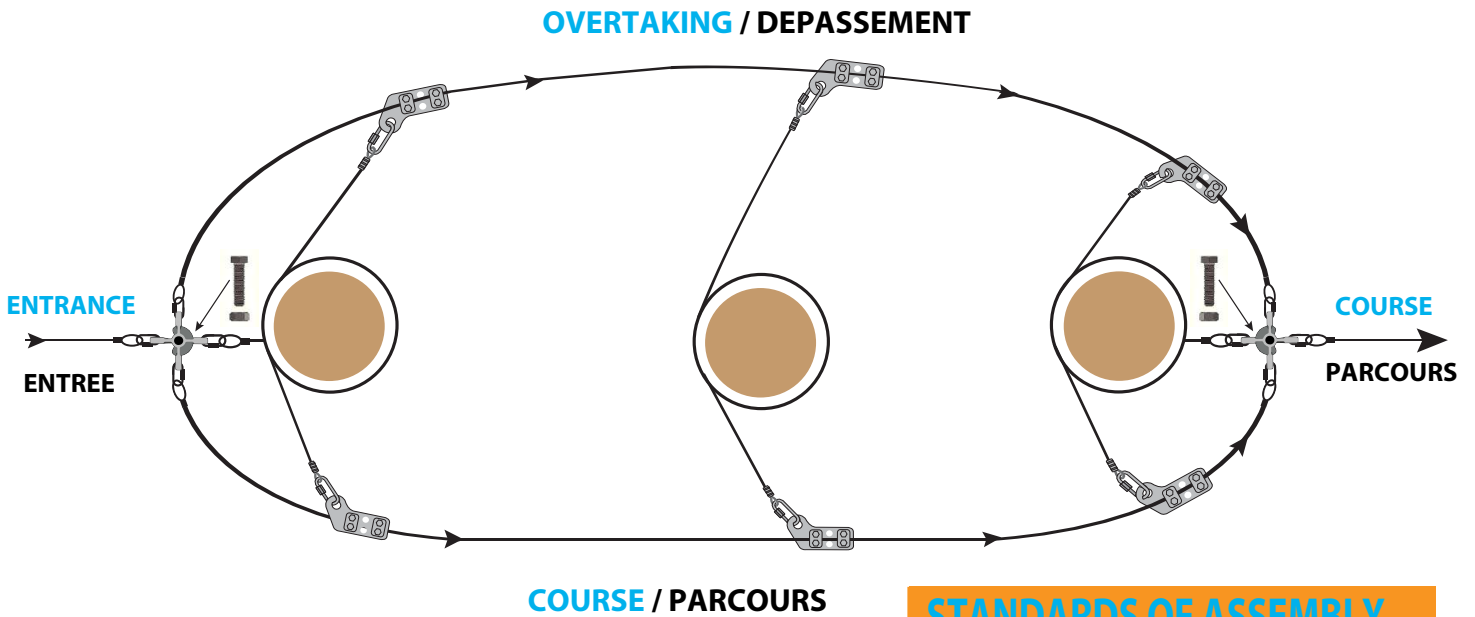

**STANDARDS OF ASSEMBLY
NORMES DE MONTAGE**



EN 15567-1
EN 13411-1/7
STANDARDS - ACCT

Opération 3

**RECOMMENDATIONS OF ASSEMBLY
RECOMMANDATIONS DE MONTAGE**



FLEXIBLE ASSEMBLY / MONTAGE SOUPLE

