

ZAZA 2 ZIP 5

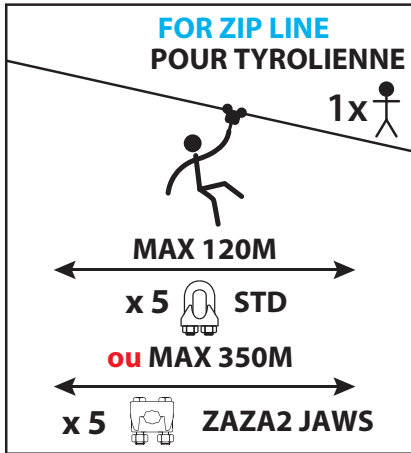

Safety Line / Ligne de vie :

Ø 12 mm or 1/2"

Galvanized steel wire rope with metal core /
Câble acier galvanisé avec âme métallique :-
-7x19

-Non rotating wire rope / Anti-giratoire
-6x26 Swaged/ Compacté

For any other type: do tests
Pour tout autre type : faire des tests

ADAPTABLE



STD 12

or

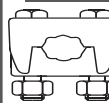

ZAZA2
JAWS

NORMES

EN 15567-1
EN 13411-1/7



ACIER INOXYDABLE

STAINLESS STEEL

INOX 316 L

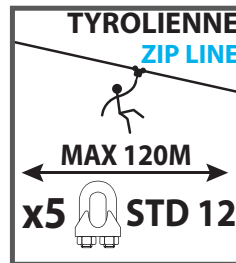
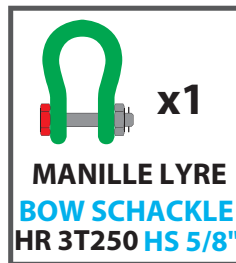

OU

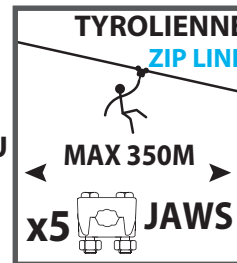

EXEMPLES DE FIXATIONS (liste non-exhaustive) / FIXATION EXAMPLE (non-exhaustive list)

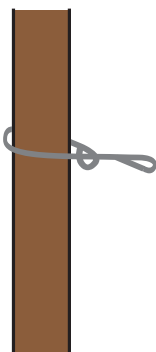

ELINGUE DE LEVAGE RONDE TEXTILE TYPE "E" CMU mini 3 tonnes

ROUND TEXTILE SLING FOR LIFTING TYPE "E" WLL mini 3 tons

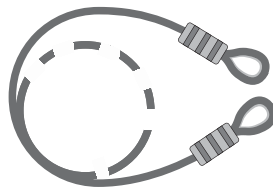

Chain HR/HS Ø 10/13 mm Grade 80 mini

NORMES: EN 13411-1/7
STANDARDS:

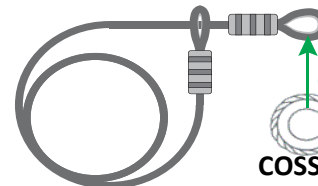

CÂBLES Ø12 or 1/2"
ÂME MÉTALLIQUE
METALLIC CORE

OK!
COSSE-COEUR / THIMBLE



La CMU des fixations doit être correctement dimensionnée / WLL of the fixing element must be correctly sized

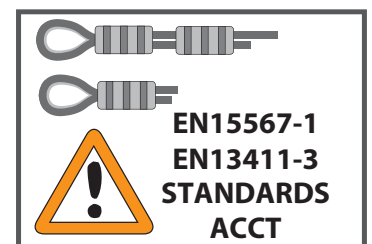
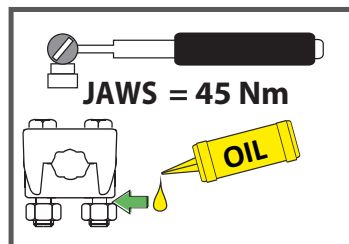
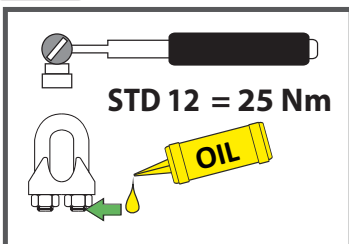

Operation 1

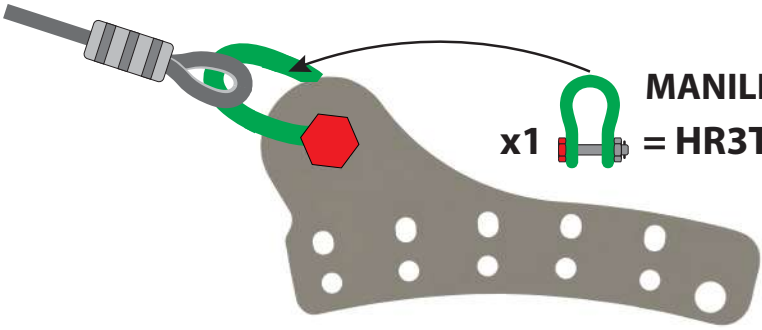

MANILLE LYRE / BOW SHACKLE
 x1 = HR3T250 - HS 5/8"

Operation 2

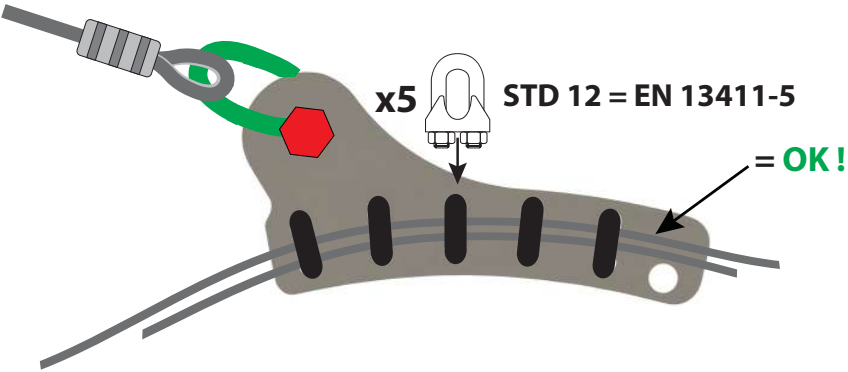

x5 STD 12 = EN 13411-5
 = OK!

**STANDARDS OF ASSEMBLY
 NORMES DE MONTAGE**



EN 15567-1
 EN 13411-1/7
 STANDARDS - ACCT



**PLAQUE DE GUIDAGE OBLIGATOIRE!
 MANDATORY GUIDING PLATE !**



Operation 2 Bis

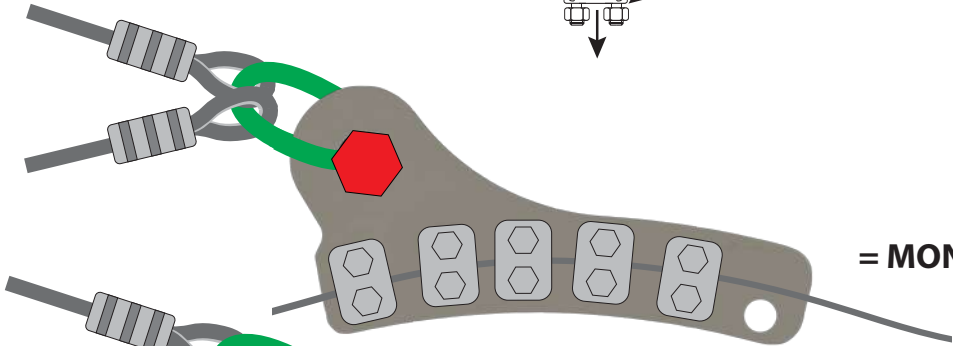

x5 ZAZA2 JAWS = 45 Nm
 OIL
 STD 12 = 25 Nm

**Same assembly direction
 Même sens de montage**

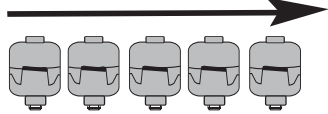

= MONO CABLE

ZIP LINE CABLE

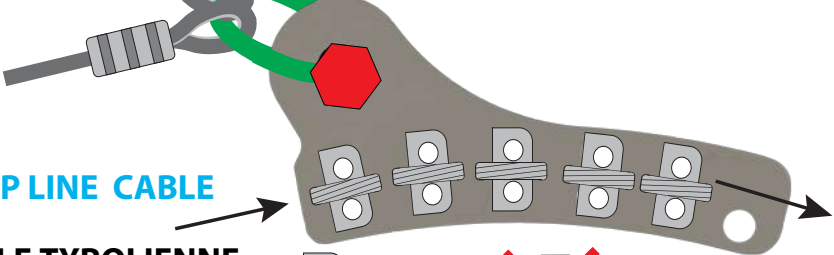

= OK!
~~= NO!~~



**MANDATORY GUIDING PLATE !
 PLAQUE DE GUIDAGE OBLIGATOIRE !**

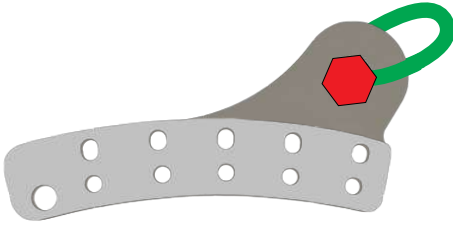

Operation 3

OBSERVE FITTING ORIENTATION OF JAWS CLAMPS

OBSERVER LE SENS DE MONTAGE DES JAWS

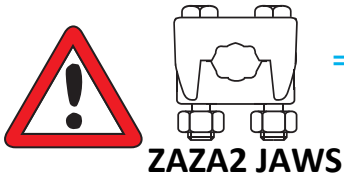

= OBSERVE THE DIRECTION OF CIRCULATION OF THE SAFETY HOOK

= OBSERVER LE SENS DE CIRCULATION DU CROCHET

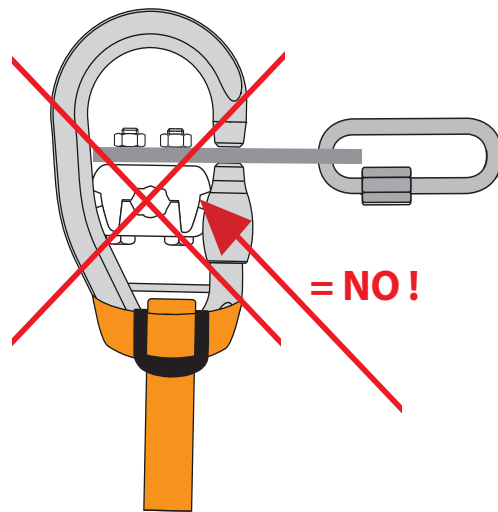
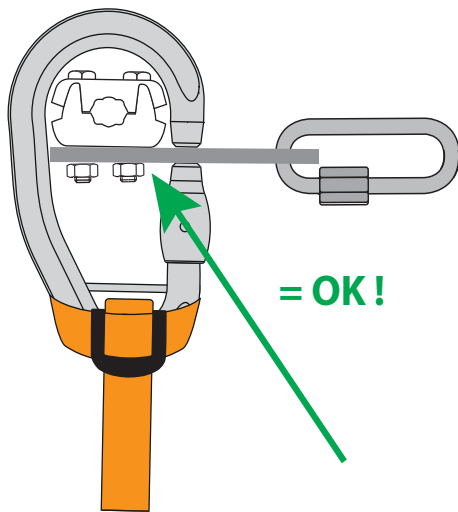
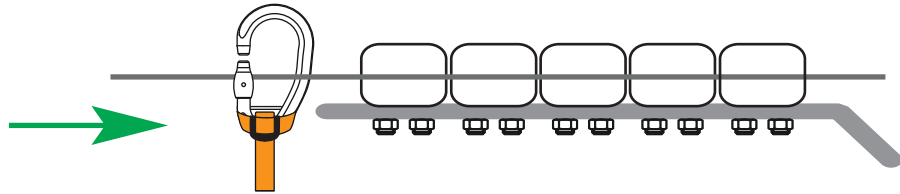

CAUTION / MISE EN GARDE

it's imperative to have a backup (redundancy plate)

il faut impérativement une platine de redondance

Operation 4

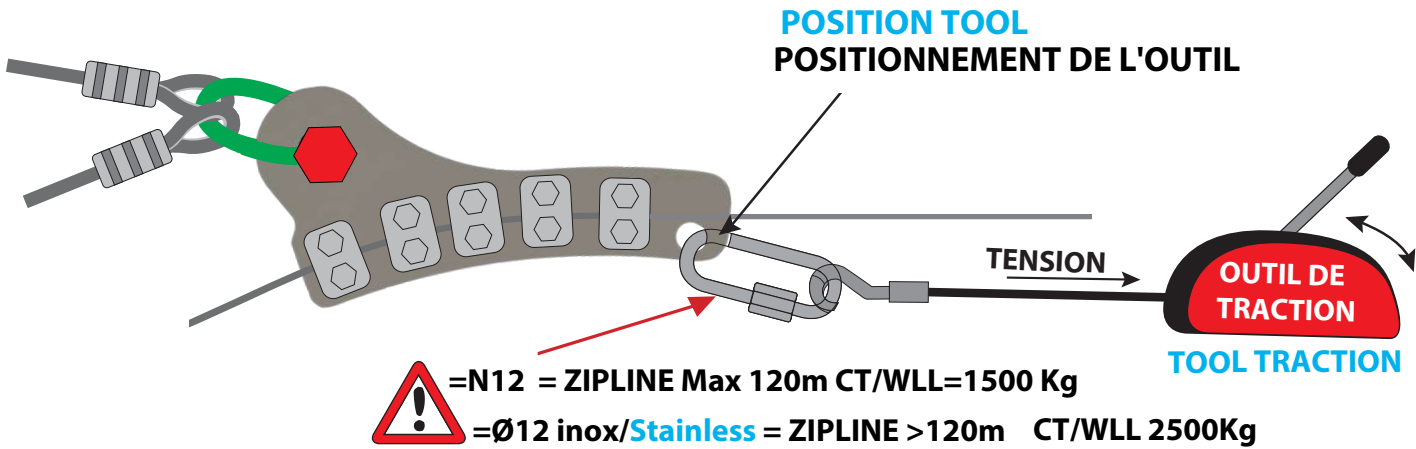

Operation 5

● **RECOMMENDATION of ASSEMBLY**
RECOMMANDATION DE MONTAGE

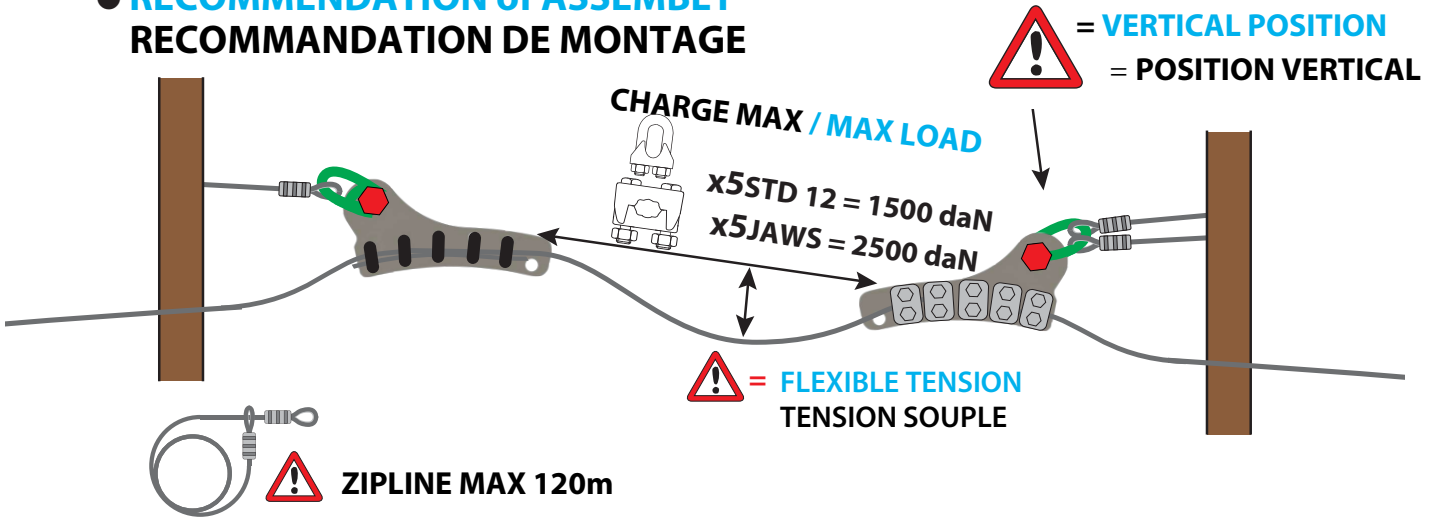

Operation 6

● **JUNCTION**

JONCTION

NOT Contractual examples
system of fixing

Exemples (non contractuel)
de systèmes de fixations

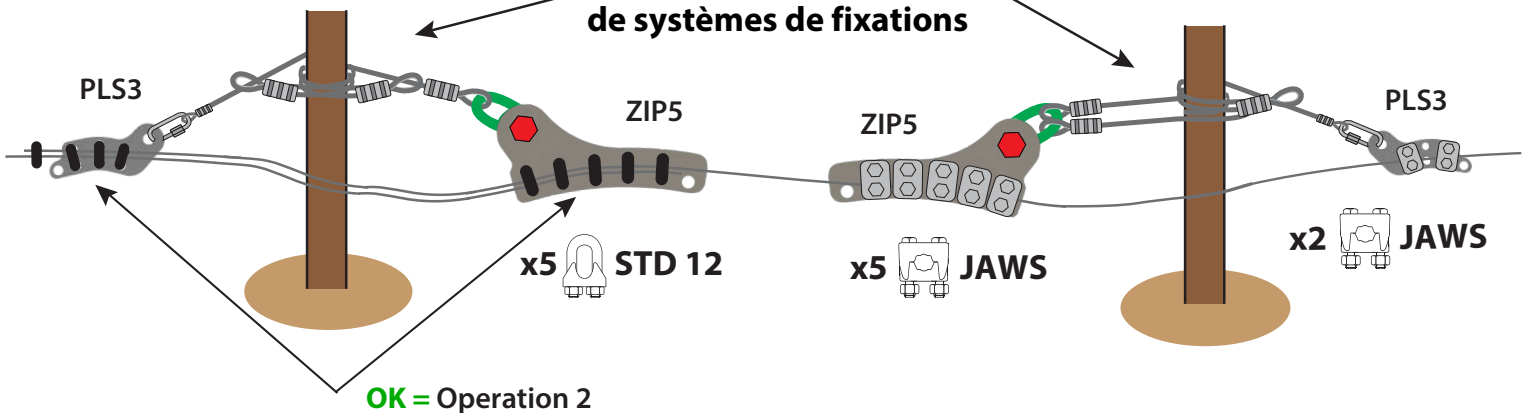



RAPPEL MECANIQUE / MECHANICAL REMINDER

