

ZAZA2 PBT

Brevet déposé N°1558856 / patent deposit

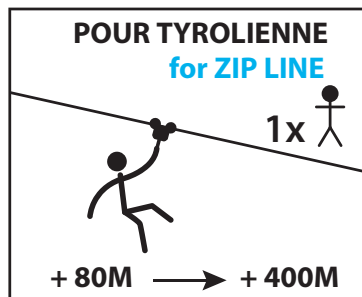

AVANTAGES/ ADVANTAGES

- Facile et simple à installer
Easy to install
- Sans SERRE-CÂBLE!
No CLAMP
- Réglage de tension rapide
Quick adjustment
- Sans maintenance
No maintenance

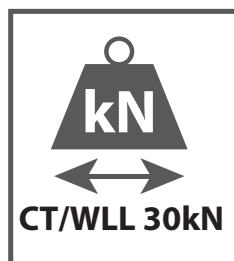

Safety Line / Ligne de vie :

ø 12 mm or 1/2 "

Galvanized steel wire rope with metal core /
Câble acier galvanisé avec âme métallique :-
- 7x19
- Non rotating wire rope / Anti-giratoire
- 6x26 Swaged/ Compacté

For any other type: do tests
Pour tout autre type : Faire des tests

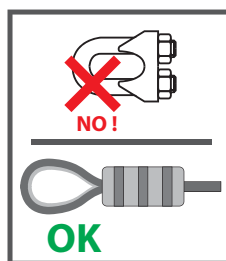

EN 15567-1
EN13411-3

STANDARDS
ACCT

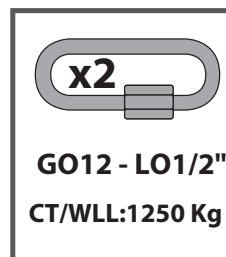
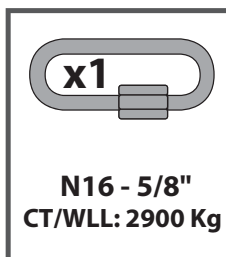
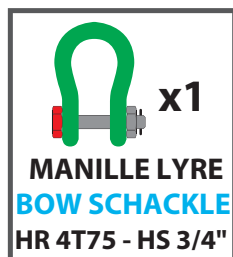
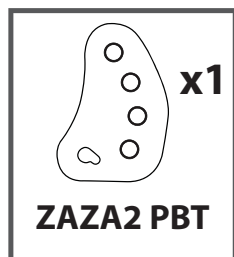

EXEMPLES DE FIXATIONS (liste non-exhaustive) / FIXATION EXAMPLE (non-exhaustive list)

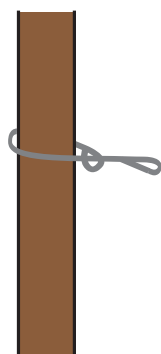

ELINGUE DE LEVAGE RONDE TEXTILE TYPE "E" CMU mini 3 tonnes
ROUND TEXTILE SLING FOR LIFTING TYPE "E" WLL mini 3 tons

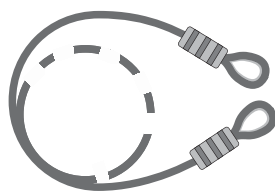

NORMES: EN 13411-1/7
STANDARDS:

CÂBLES ø12 or 1/2"
ÂME METALLIQUE
METALLIC CORE

OK!
COSSE-COEUR / THIMBLE



Chain HR/HS Ø 10/13 mm Grade 80 mini



La CMU des fixations doit être correctement dimensionnée / WLL of the fixing element must be correctly sized

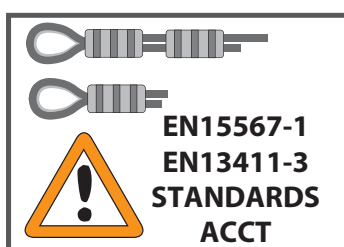

Operation 1

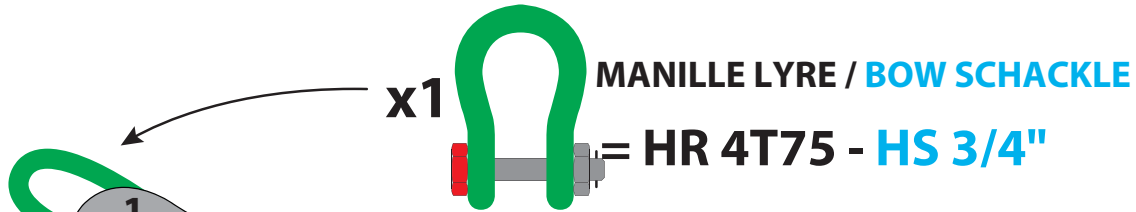

**NORMES DE MONTAGE
STANDARDS ASSEMBLIES**



EN 15567-1
EN 13411-1/7
STANDARDS - ACCT

4 positions

Operation 2

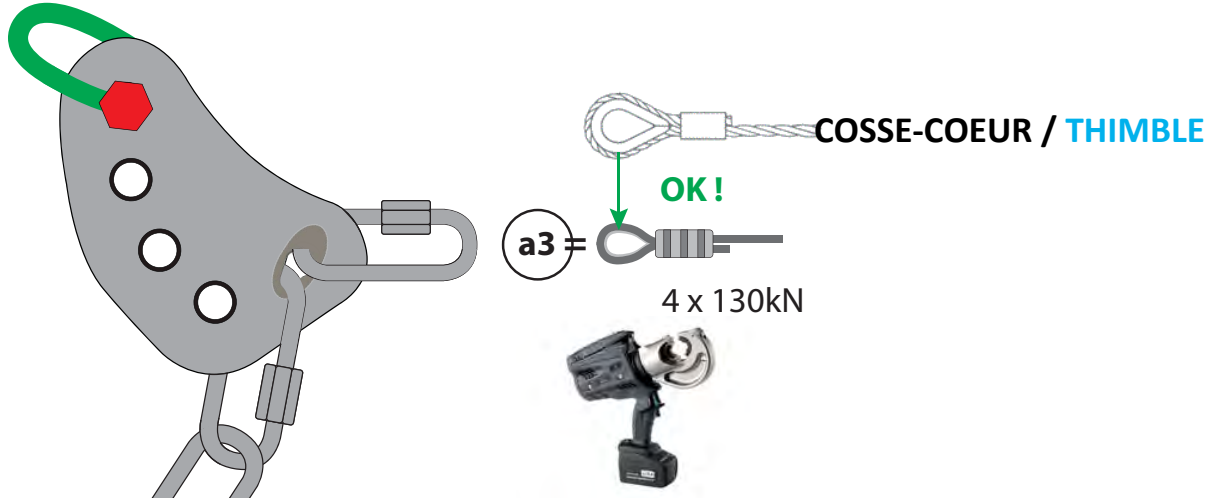
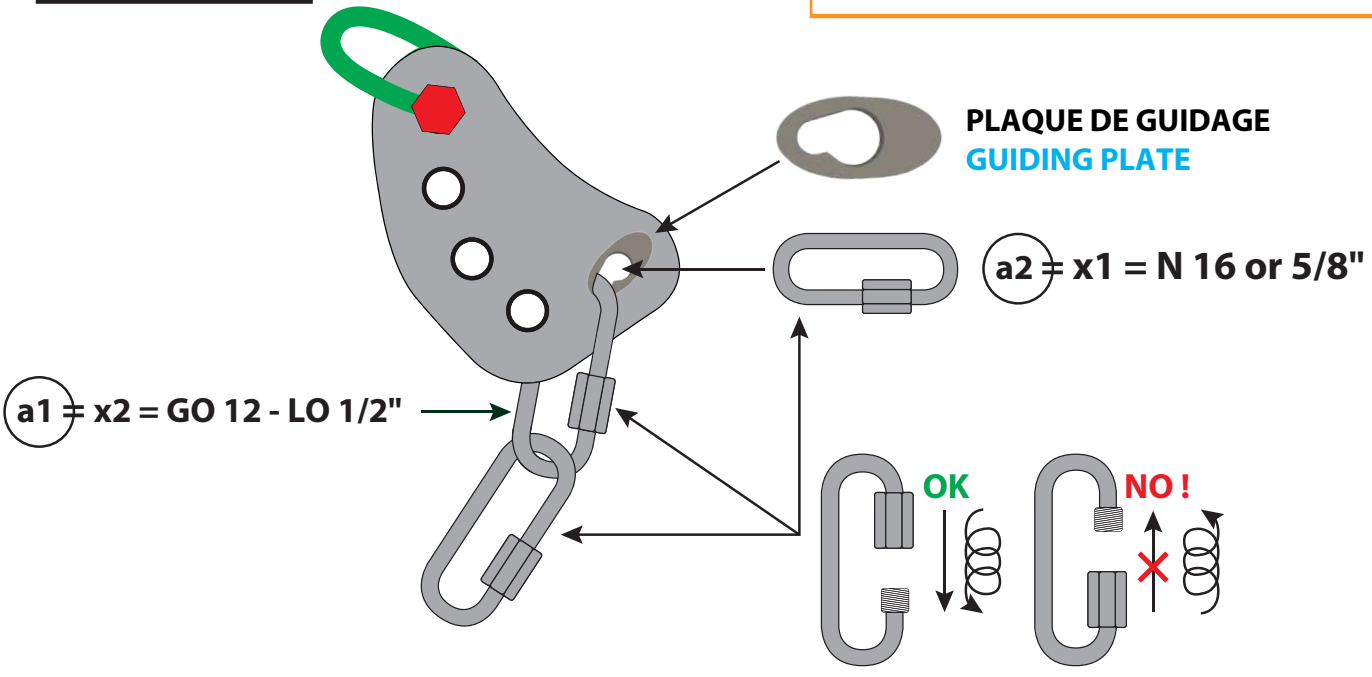

Operation 3

• DEPART DE LA TYROLIENNE : INSTALLATION DU CÂBLE = **SANS PLATINE**
START ZIP LINE: CABLE INSTALLATION = NO PLATE

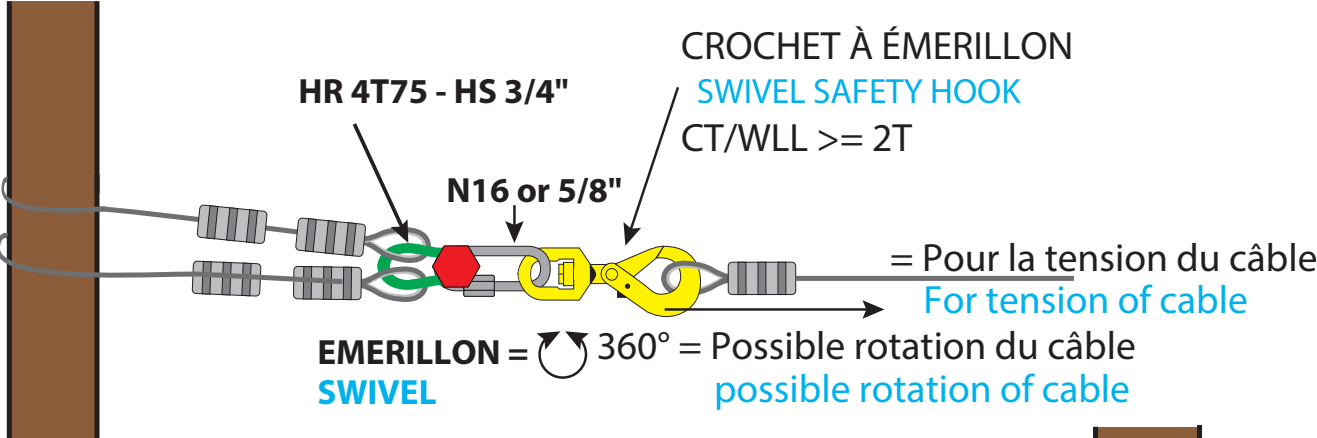

Operation 4

ARRIVEE DE LA TYROLIENNE : INSTALLATION DE LA PLATINE
ARRIVAL ZIP LINE: PLATE INSTALLATION

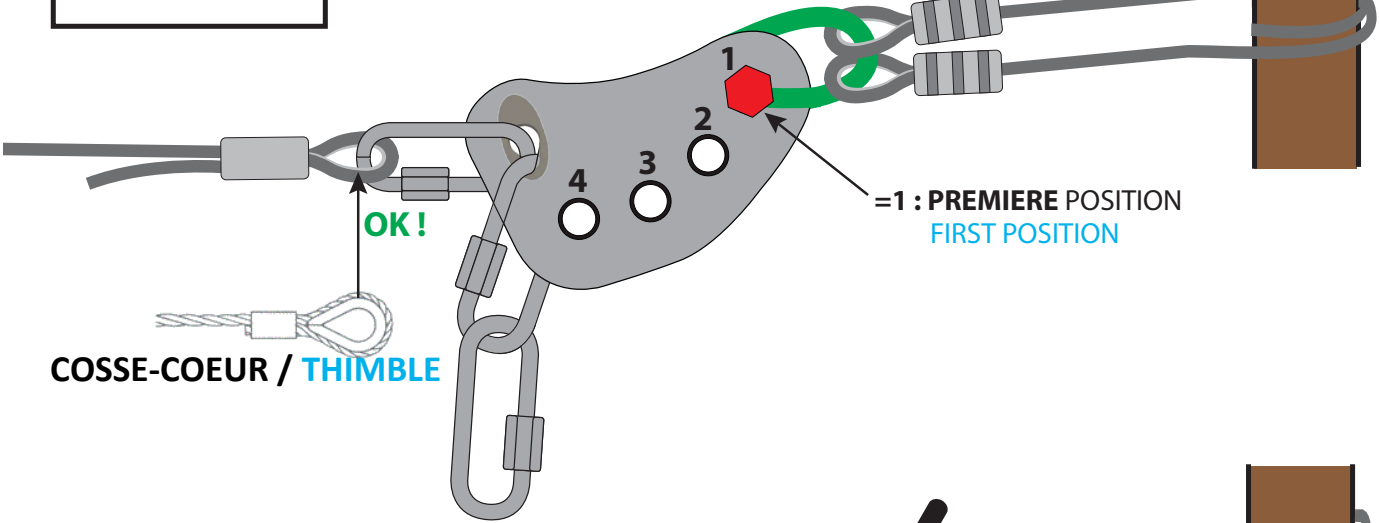

Operation 5

• TENSION DU CÂBLE
CABLE TENSION

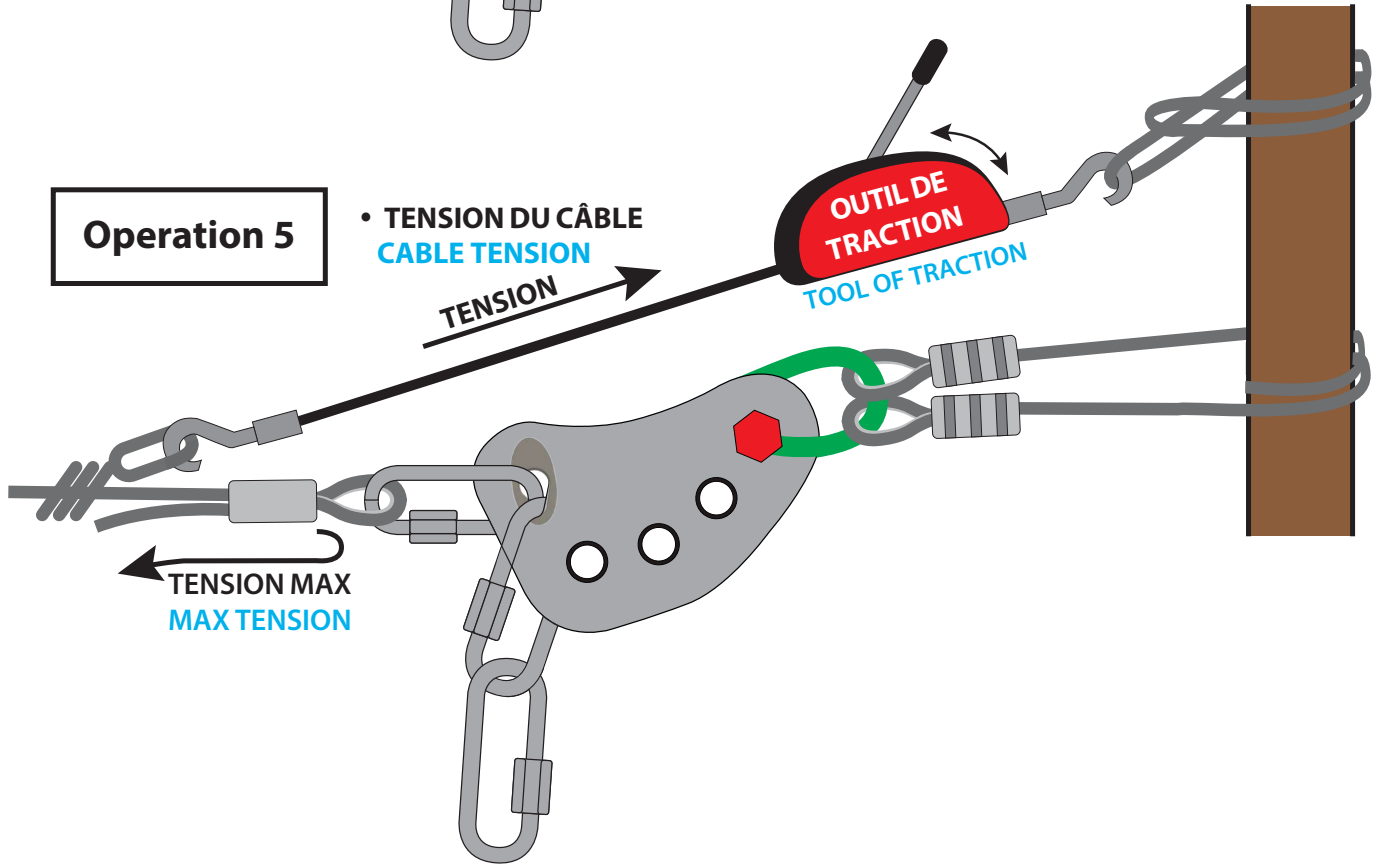

Operation 6

• POUR SERTIR
TO CRIMP

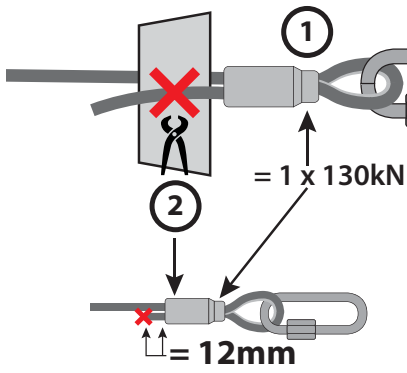

Couper le brin mort
Cut the dead end rope

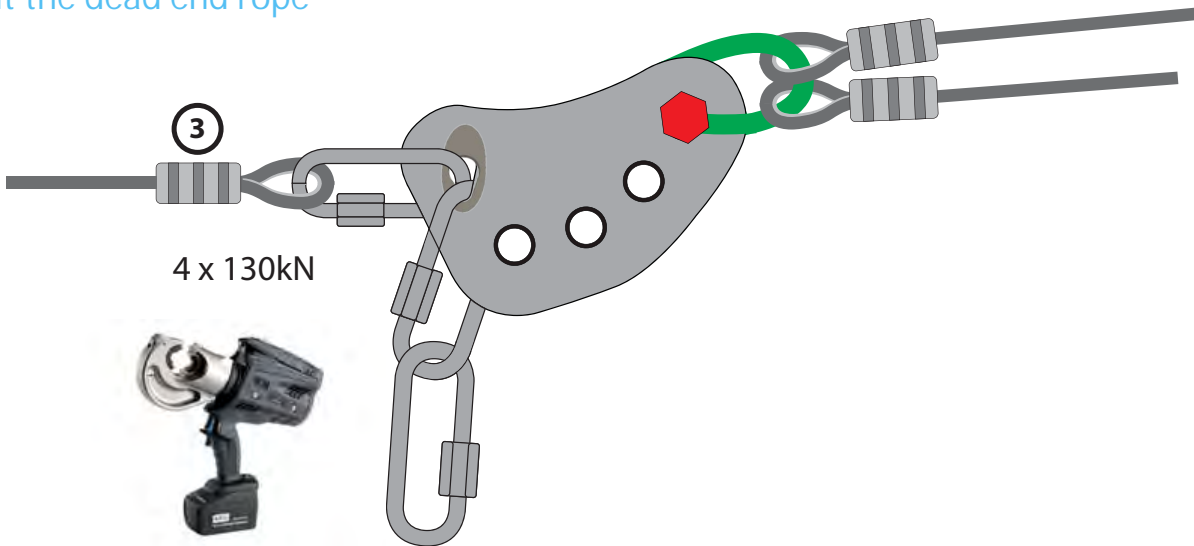

Operation 7

DEPART DE LA TYROLIENNE : INSTALLATION DE LA PLATINE
START ZIP LINE : PLATE INSTALLATION

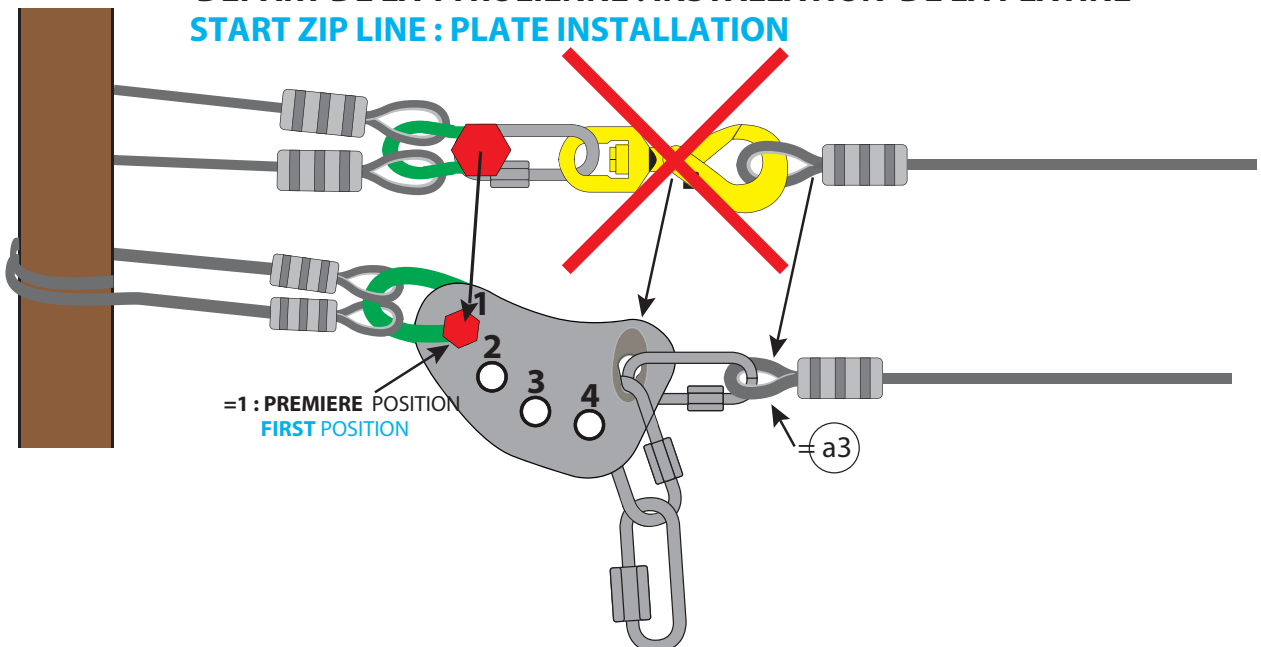

Operation 8

- AJUSTER LA TENSION DU CÂBLE
ADJUST the CABLE TENSION

PLATINE DE DEPART DE LA TYROLIENNE ZIP LINE STARTING PLATE

1

- A AJUSTER EN PREMIER
FIRST ADJUSTEMENT

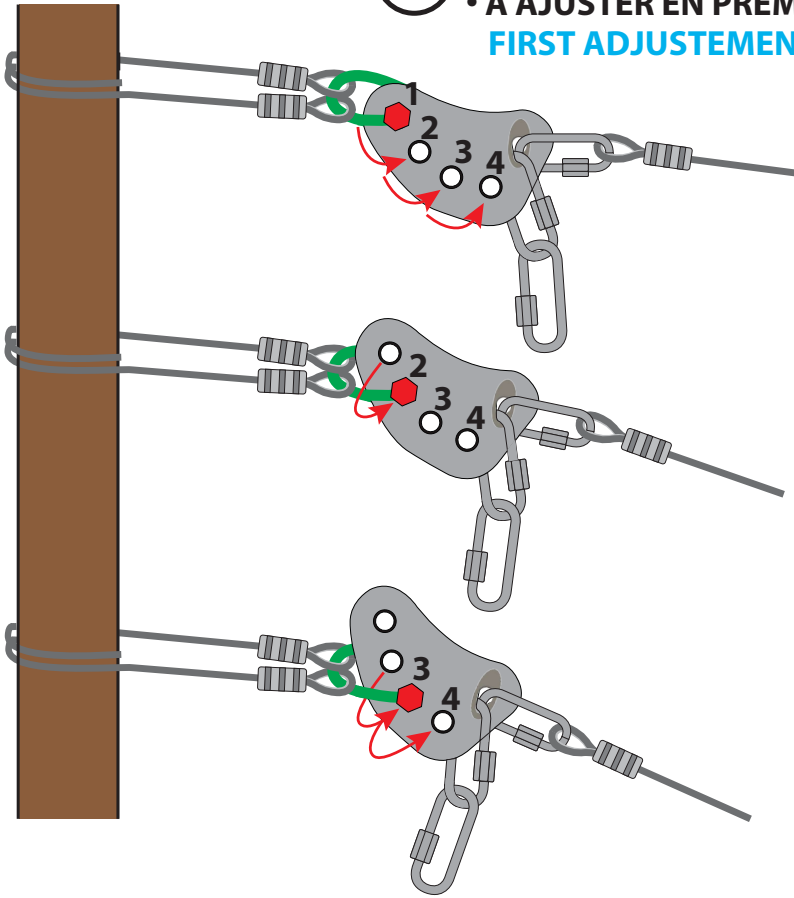

2

PLATINE D'ARRIVEE DE LA TYROLIENNE ZIP LINE ARRIVAL PLATE

- A AJUSTER EN DERNIER
LAST ADJUSTEMENT

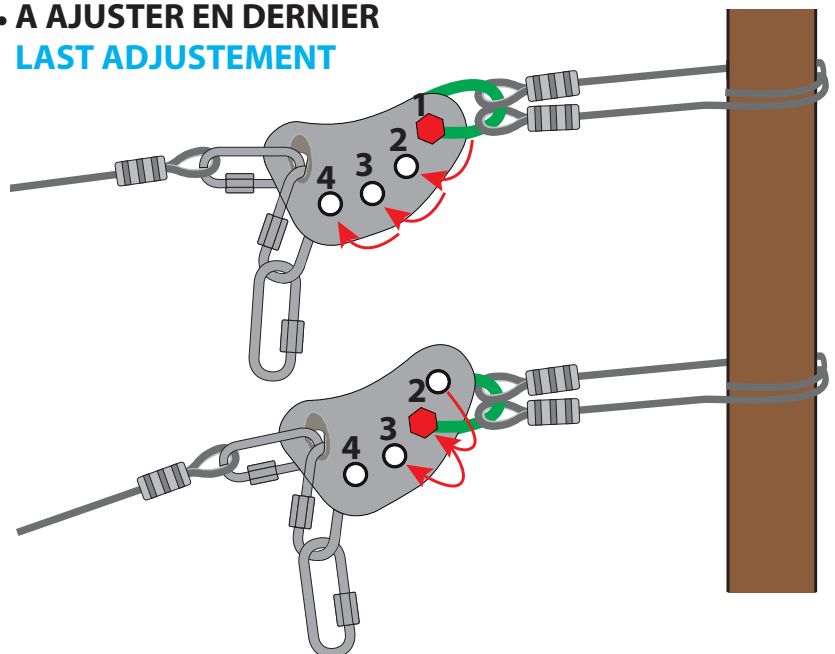

Operation 9

• RECOMMANDATION DE MONTAGE
RECOMENDATION OF ASSEMBLY

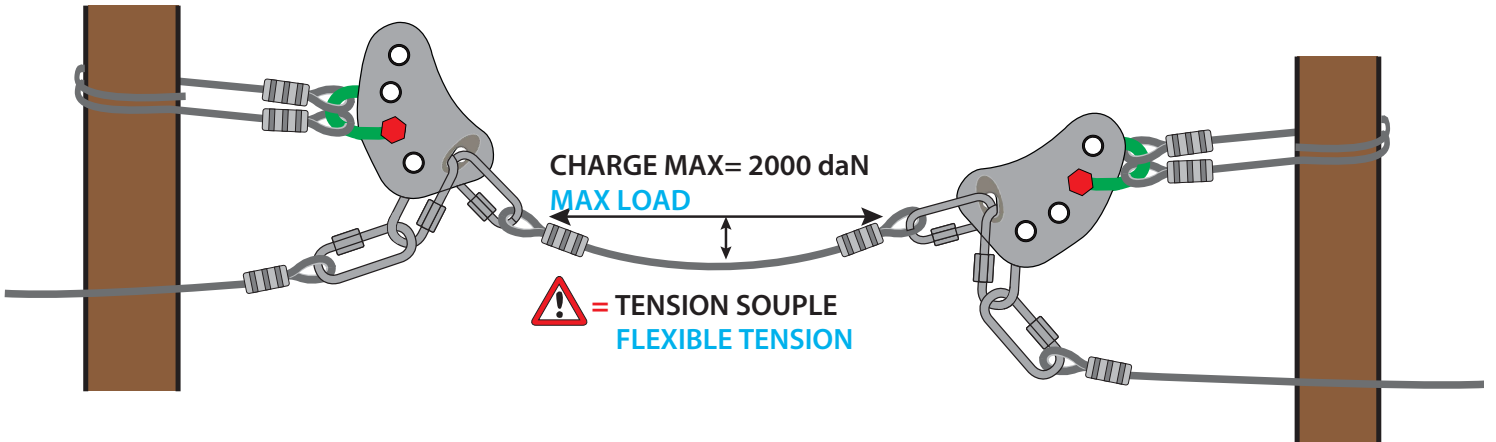

Rappel /Reminder:

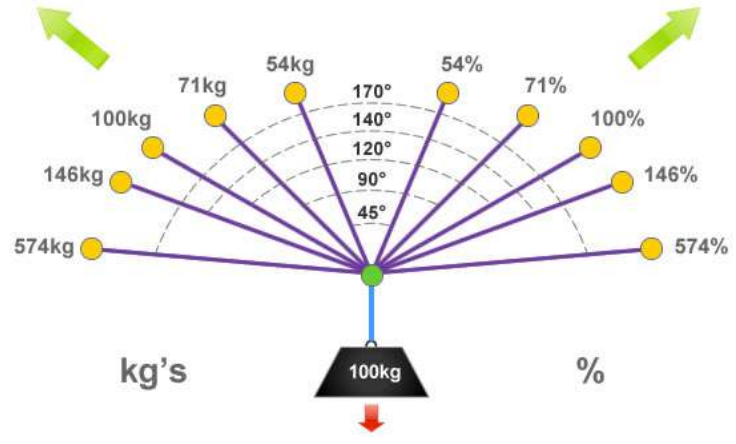

Operation 10

• JONCTION
JUNCTION

Exemples (non contractuel)
de systèmes de fixations
Alternative example and
suggestion for fixation

